



ALPHA2 L

Model C



GB: Warning

This appliance can be used by children aged from 8 years and above and persons with reduced physical, sensory or mental capabilities or lack of experience and knowledge if they have been given supervision or instruction concerning use of the appliance in a safe way and understand the

hazards involved. Children shall not play with the appliance. Cleaning and user maintenance shall not be made by children without supervision.



BG: Предупреждение

Този продукт може да се използва от деца на 8 и повече години и лица с физически, сетивни или умствени увреждания или липса на опит и познания за продукта, ако са под надзор или са ясно инструктирани за безопасно използване на продукта. Такива лица трябва също да са наясно с опасностите, произтичащи

от използването на продукта. Никога не допускайте деца да си играят с продукта. Почистването и поддръжката от потребителя не трябва да се извършват от деца или лица с понижени физически, сетивни или умствени способности без съответен надзор.



RO: Avertizare

Acest produs poate fi utilizat de copiii cu vârsta de cel puțin 8 ani precum și de persoanele cu capacități fizice, senzoriale sau mentale reduse sau care nu au experiență cu, și cunoștințe despre produs, cu condiția de a fi sub supraveghere sau de a li se da instrucțiuni clare pentru utilizarea produsului în condiții de

siguranță. Aceste persoane trebuie de asemenea să înțeleagă pericolele implicate de utilizarea produsului. Nu permiteți niciodată copiilor să se joace cu produsul. Curățarea și întreținerea de către utilizator nu trebuie efectuate de copii sau persoane cu capacități fizice, senzoriale sau mentale reduse fără o supraveghere corespunzătoare.

UA: Попередження

Це обладнання може використовуватися дітьми віком від 8 років і старше, а також особами з обмеженими фізичними, сенсорними або розумовими здібностями, або без досвіду роботи та знання за умови, що такі особи знаходяться під наглядом або пройшли інструктаж з безпечного використання цього обладнання. Такі особи повинні також розуміти фак-

тори небезпеки, пов'язані з використанням обладнання. Суворо забороняється дозволяти дітям гратися з обладнанням. Очистка та технічне обслуговування не повинні здійснюватися дітьми або особами з обмеженими фізичними, сенсорними або розумовими здібностями без належного нагляду.





Max. 95 % RH
IPX4D



Min./Max.
+2 °C / +110 °C 

Max. 1.0 MPa
(10 bar) 

Min./Max.
0 °C / +40 °C 

< 43 dB(A) 



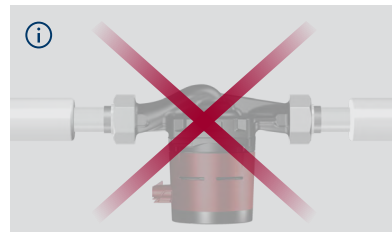
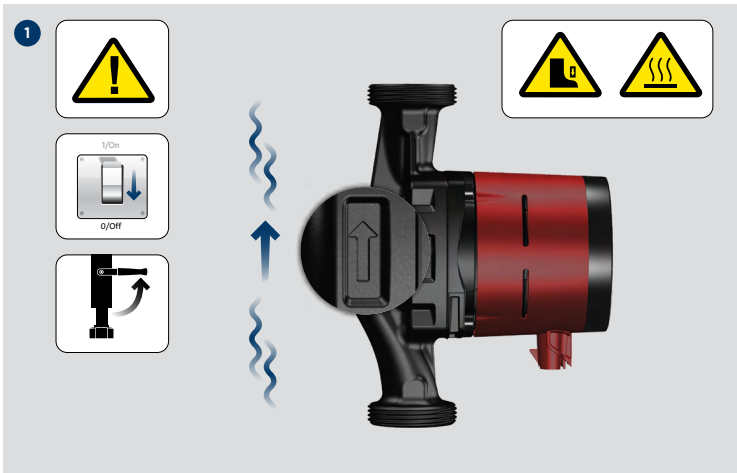

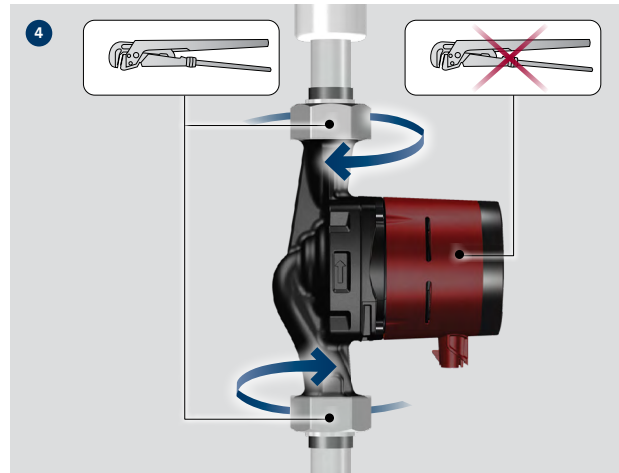
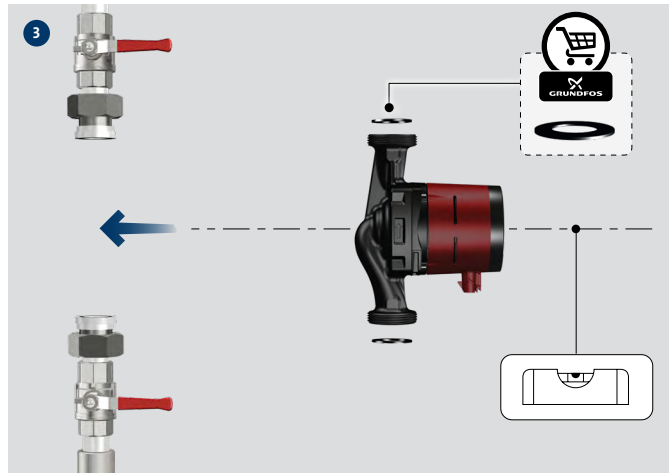
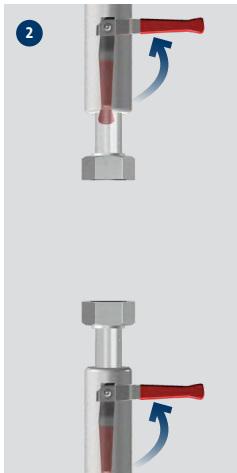

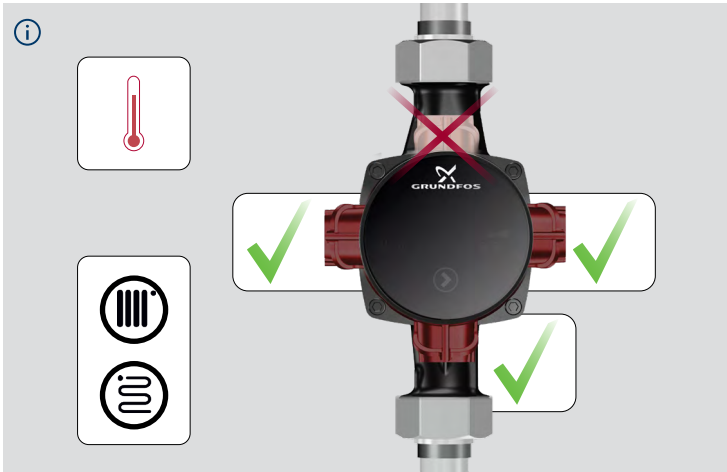

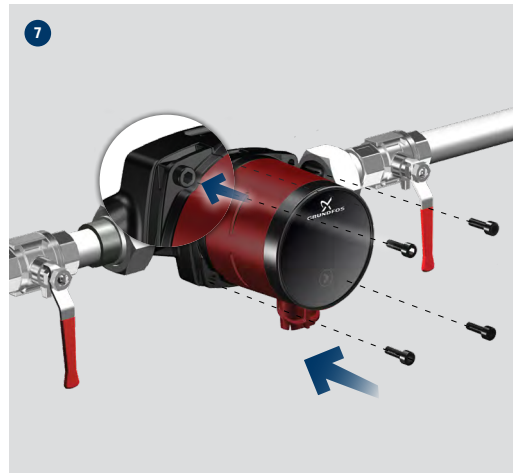
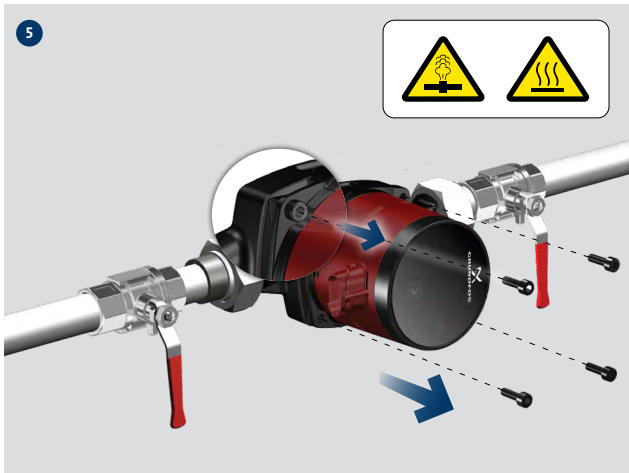

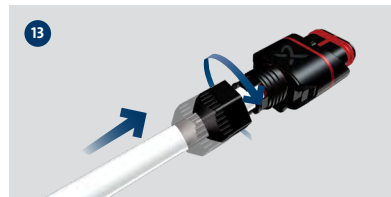
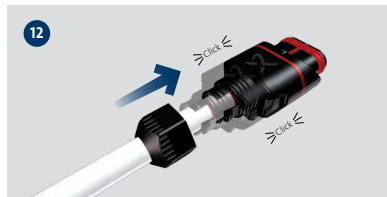
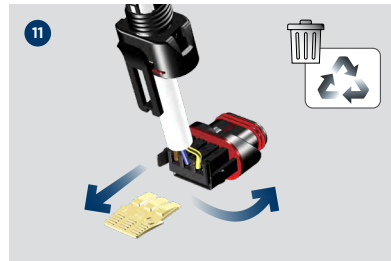
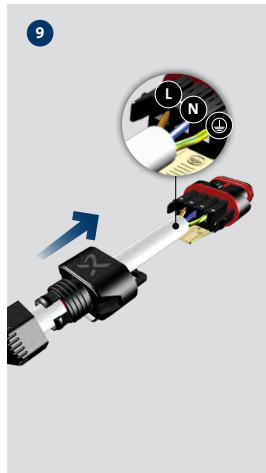
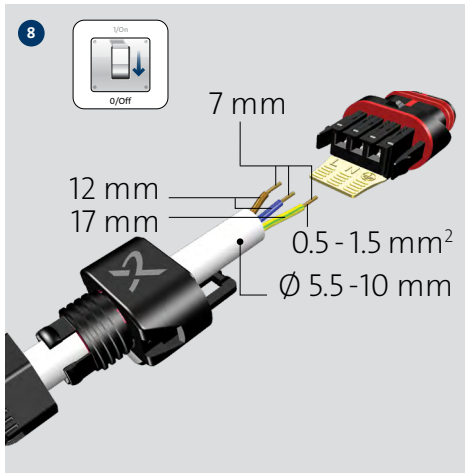



14

1 × 230 V ± 10 %
~ 50/60 Hz ⚡

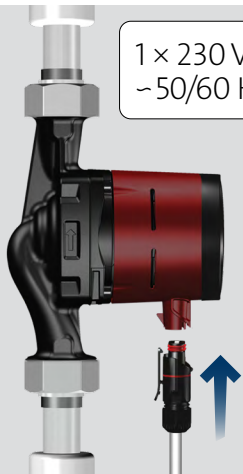

15



i

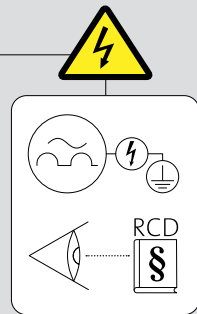
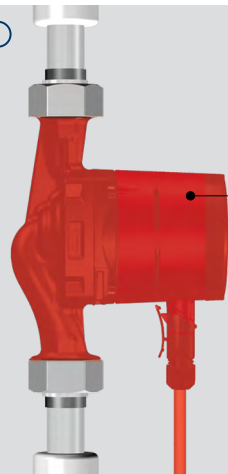

16



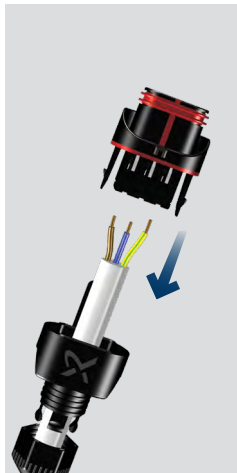
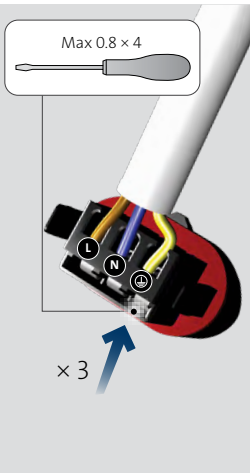
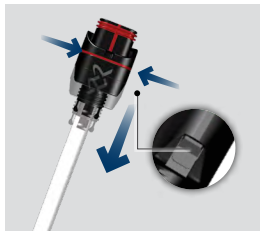
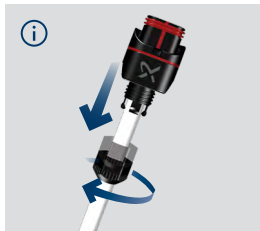
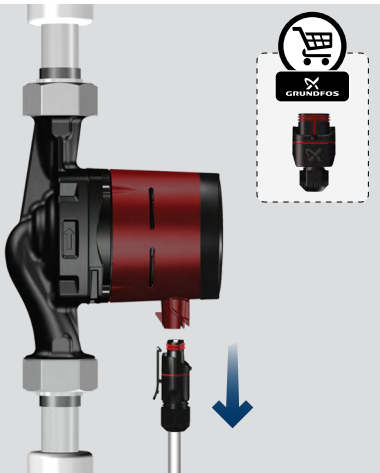

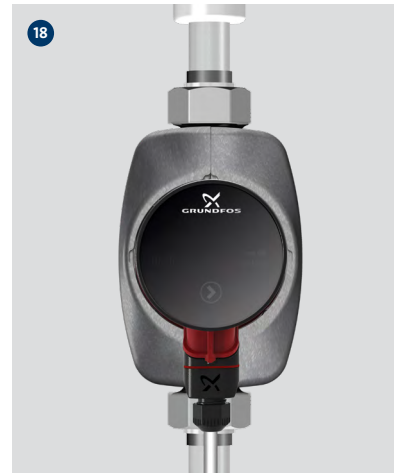



23



i

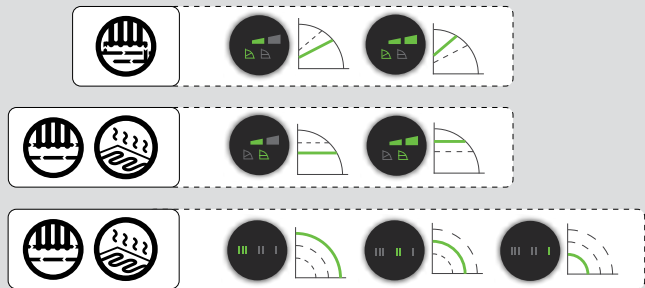

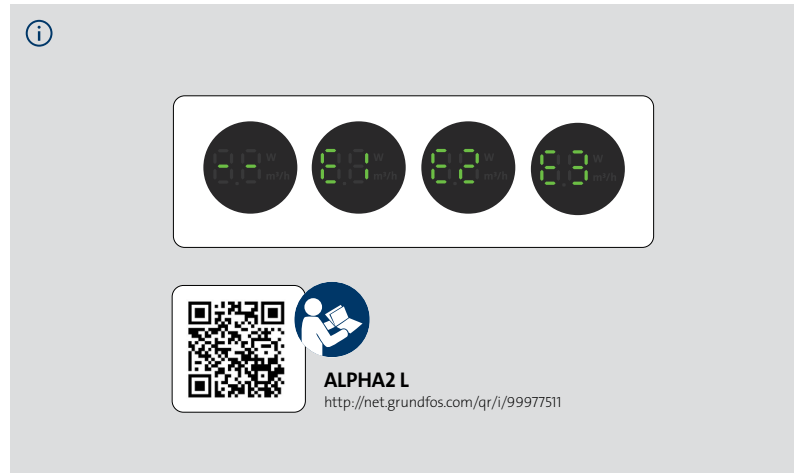



GB: The crossed-out wheellie bin symbol on a product means that it must be disposed of separately from household waste. When a product marked with this symbol reaches its end of life, take it to a collection point designated by the local waste disposal authorities. The separate collection and recycling of such products will help protect the environment and human health.

BG: Зачеркнатият символ на кофа за отпадъци върху продукта означава, че той трябва да бъде изхвърлен отделно от битовите отпадъци. Когато маркираният с този символ продукт достигне края на експлоатационния си живот, отнесете го в пункт за събиране на такива отпадъци, посочен от местните организации за третиране на отпадъци. Разделното събиране и рециклиране на подобни продукти ще спомогне за опазването на околната среда и здравето на хората.



RO: Simbolul de pubeză întretăiată aflată pe un produs denotă faptul că acesta trebuie depus la deșeuri separat de gunoiul menajer. Când un produs cu acest simbol ajunge la sfârșitul duratei de viață, acesta trebuie dus la un punct de colectare desemnat de către autoritățile locale de administrare a deșeurilor. Colectarea și reciclarea separate ale acestor produse vor ajuta la protejarea mediului înconjurător și a sănătății umane.

UA: Символ перекресленого сміттевого контейнера на виробі означає, що він повинен утилізуватися окремо від побутових відходів. Коли термін служби виробу, на якому є такий символ, добігає кінця, його слід відвезти до пункту збору сміття, визначеного місцевим управлінням з видалення відходів. Окрема утилізація таких виробів допоможе захистити довкілля та здоров'я людей.

**GB: EU declaration of conformity**

We, Grundfos, declare under our sole responsibility that the product marked with ALPHA1 model B, ALPHA2 L model C, ALPHA2 model D/E to which this declaration relates, are in conformity with these Council directives on the approximation of the laws of the EU member states:

BG: Декларация за съответствие на ЕО

Ние, фирма Grundfos, заявяваме с пълна отговорност, че продуктите ALPHA1 model B, ALPHA2 L model C, ALPHA2 model D/E за които се отнася настоящата декларация, отговарят на следните директиви на Съвета за уеднаквяване на правните разпоредби на държавите-членки на ЕО:

RO: Declarația de conformitate UE

Noi Grundfos declarăm pe propria răspundere că produsele ALPHA1 model B, ALPHA2 L model C, ALPHA2 model D/E la care se referă această declarație, sunt în conformitate cu Directivetele de Consiliu specificate mai jos privind armonizarea legilor statelor membre UE:

UA: Декларация відповідності директивам ЕУ

Ми, компанія Grundfos, під нашу одноосібну відповідальність заявляємо, що вироби ALPHA1 model B, ALPHA2 L model C, ALPHA2 model D/E, до яких відноситься нижченаведена декларація, відповідають директивам ЕУ, переліченим нижче, щодо тотожності законів країн-членів ЄС.

Low Voltage Directive (2014/35/EU)

Standards used:

- EN 60335-1:2012 + AC:2014 + A11:2014 + A13:2017 + A1:2019 + A14:2019 + A2:2019 + A15:2021
- EN 60335-2-51:2003 + A1:2008 + A2:2012

EMC Directive (2014/30/EU)

Standards used:

- EN 55014-1:2006/A1:2009/A2:2011
- EN 55014-2:2015
- EN 61000-3-2:2014
- EN 61000-3-3:2013

Ecodesign Directive (2009/125/EC)

- Commission Regulation (EC) No 641/2009
- Commission Regulation (EC) No 622/2012

Standards used:

- EN 16297-1:2012
- EN 16297-2:2012

RoHS Directives (2011/65/EU) and (2015/863/EU)

Standard used:

- EN IEC 63000:2018

Bjerringbro, 17th of February 2022

Jannek Uldal-Christesen
Senior Director

GRUNDFOS Holding A/S,
Poul Due Jensens Vej 7,
8850 Bjerringbro, Denmark

*Person authorised to compile technical file
and empowered to sign the EC declaration of
conformity.*





Argentina
Bombas GRUNDFOS de Argentina S.A.
Ruta Panamericana km. 37.500
Centro Industrial Garin
1619 Garin Pcia. de B.A.
Phone: +54-3327 414 444
Telefax: +54-3327 45 3190

Australia
GRUNDFOS Pumps Pty Ltd.
PO. Box 2040
Regency Park
South Australia 5942
Phone: +61-8-8461-4611
Telefax: +61-8-8340 0155

Austria
GRUNDFOS Pumpen Vertrieb Ges.m.b.H.
Grundfosstraße 2
A-5082 Grödig/Salzburg
Tel.: +43-6246-883-0
Telefax: +43-6246-883-30

Belgium
N.V. GRUNDFOS Bellux S.A.
Boomssesteenweg 81-83
B-2630 Aartselaar
Tél.: +32-3-870 7300
Télécopie: +32-3-870 7301

Belarus
Представительство ГРУНДФОС в Минске
220125, Минск
ул. Шафарнянская, 11, оф. 56, БЦ «Порт»
Тел.: +375 17 397 397 3
+375 17 397 397 4
Факс: +375 17 397 397 1
E-mail: minska@grundfos.com

Bosnia and Herzegovina
GRUNDFOS Sarajevo

Zmaja od Bosne 7-7A,
BH-71000 Sarajevo
Phone: +387 33 592 480
Telefax: +387 33 590 465
www.ba.grundfos.com
e-mail: grundfos@bih.net.ba

Brazil
BOMBAS GRUNDFOS DO BRASIL
Av. Humberto de Alencar Castelo Branco, 630
CEP 09850 - 300
São Bernardo do Campo - SP
Phone: +55-11 4393 5533
Telefax: +55-11 4343 5015

Bulgaria
Grundfos Bulgaria EOOD
Slatina District
Iztocna Tangenta street no. 100
BG - 1592 Sofia
Tel. +359 2 49 22 200
Fax. +359 2 49 22 201
email: bulgaria@grundfos.bg

Canada
GRUNDFOS Canada Inc.
2941 Brighton Road
Oakville, Ontario
L6H 6C9
Phone: +1-905 829 9533
Telefax: +1-905 829 9512

China
GRUNDFOS Pumps (Shanghai) Co. Ltd.
10F The Hub, No. 33 Suhong Road
Minhang District
Shanghai 201106
PRC
Phone: +86 21 612 252 22
Telefax: +86 21 612 253 33

COLOMBIA
GRUNDFOS Colombia S.A.S.
Km 15 via Siberia-Cota Conj.
Potrero Chico,

Parque Empresarial Arcos de Cota Bod. 1A.
Cota, Cundinamarca
Phone: +57(1)-2913444
Telefax: +57(1)-8764586

Croatia
GRUNDFOS CROATIA d.o.o.
Buzinski prilaz 38, Buzin
HR-10010 Zagreb
Phone: +385 1 6595 400
Telefax: +385 1 6595 499
www.hrgrundfos.com

GRUNDFOS Sales Czechia and Slovakia s.r.o.
Cajkovského 21
779 00 Olomouc
Phone: +420-585-716 111

Denmark
GRUNDFOS DK A/S
Martin Bachs Vej 3
DK-8850 Bjerringbro
Tlf.: +45-87 50 50 50
Telefax: +45-87 50 51 51
E-mail: info_GDK@grundfos.com
www.grundfos.com/DK

Estonia
GRUNDFOS Pumps Eesti OÜ
Peterburi tee 92G
11415 Tallinn
Tel: + 372 606 1690
Fax: + 372 606 1691

Finland
OY GRUNDFOS Pumput AB
Trukkikuja 1
FI-01360 Vantaa
Phone: +358-(0) 207 889 500

France
Pompes GRUNDFOS
Distribution S.A.
Parc d'Activités de Chesnes
57, rue de Malacornbe

F-38290 St. Quentin Fallavier (Lyon)
Tél.: +33-4 74 82 15 15
Télécopie: +33-4 74 94 10 51

Germany
GRUNDFOS GMBH
Schlüterstr. 33
40699 Erkrath
Tel.: +49-(0) 211 929 69-0
Telefax: +49-(0) 211 929 69-3799
e-mail: infoservice@grundfos.de
Service in Deutschland:
e-mail: kundendienst@grundfos.de

Greece
GRUNDFOS Hellas A.E.B.E.
20th km. Athinon-Markopoulou Av.
P.O. Box 71
GR-19002 Peania
Phone: +0030-210-66 83 400
Telefax: +0030-210-66 46 273

Italy
GRUNDFOS Pompe Italia S.r.l.
Via Gran Sasso 4
I-20060 Truccazzano (Milano)
Tel.: +39-02-95838112
Telefax: +39-02-95309290 / 95838461

Japan
GRUNDFOS Pumps K.K.
1-2-3, Shin-Miyakoda, Kita-ku,
Hamamatsu
431-2103 Japan
Phone: +81 53 428 4760
Telefax: +81 53 428 5005

Korea
GRUNDFOS Pumps Korea Ltd.
6th Floor, Aju Building 679-5
Yeoksam-dong, Kangnam-ku,
135-916
Seoul, Korea
Phone: +82-2-5317 600
Telefax: +82-2-5633 725

India
GRUNDFOS Pumps India Private Limited

118 Old Mahabalipuram Road
Thoraiakkam
Deglaja bizness centrs
Augusta Deglaja ielā 60, LV-1035, Riga,
Tālr.: +371 714 9640, 7 149 641
Fakss: +371 914 9646

Indonesia
PT. GRUNDFOS POMPA
Graha Intirub Lt. 2 & 3
Jln. Cililitan Besar No.454. Makasar,
Jakarta Timur
ID-Jakarta 13650
Phone: +62 21-469-51900
Telefax: +62 21-460 6910 / 460 6901

Ireland
GRUNDFOS (Ireland) Ltd.
Unit A, Merrywell Business Park
Ballymount Road Lower
Dublin 12
Phone: +353-1-4089 800
Telefax: +353-1-4089 830

Malaysia
GRUNDFOS Pumps Sdn. Bhd.
7 Jalan Peguam U1/25
Glenmarie Industrial Park
40150 Shah Alam
Selangor
Phone: +60-3-5569 2922
Telefax: +60-3-5569 2866

Mexico
Bombas GRUNDFOS de México S.A. de CV.
Boulevard TLC No. 15
Parque Industrial Stiva Aeropuerto
Apodaca, N.L. 66600
Phone: +52-81-8144 4000
Telefax: +52-81-8144 4010

Netherlands
GRUNDFOS Netherlands
Veluwezoom 35
1326 AE Almere
Postbus 22015
1302 CA ALMERE
Tel.: +31-88-478 6336
Telefax: +31-88-478 6332
E-mail: info_gnl@grundfos.com

New Zealand
GRUNDFOS Pumps NZ Ltd.
17 Beatrice Tinsley Crescent

Latvia
SIA GRUNDFOS Pumps Latvia
Deglaja bizness centrs
Augusta Deglaja ielā 60, LV-1035, Riga,
Tālr.: +371 714 9640, 7 149 641
Fakss: +371 914 9646

Lithuania
GRUNDFOS Pumps LIAB
Smolensko g. 6
LT-03201 Vilnius
Tel: + 370 52 395 430
Fax: + 370 52 395 431

Poland
GRUNDFOS Pompy Sp. z o.o.
ul. Klonowa 23
Baranowo k. Poznania
PL-62-081 Przeźmierowo
Tel: (+48-61) 650 13 00
Fax: (+48-61) 650 13 50

Portugal
Bombas GRUNDFOS Portugal, S.A.
Rua Calvet de Magalhães, 241
Apartado 1079
P-2770-153 Paço de Arcos
Tel.: +351-21-440 76 00
Telefax: +351-21-440 76 90

Romania
Grundfos Pompe România SRL
S-PARK BUSINESS CENTER,
Clădirea A2,
etaj 2, Str. Tipografilor, Nr. 11-15,
Sector 1,
Cod 013714, Bucuresti, Romania,
Tel: 004 021 2004 100
E-mail: romania@grundfos.ro
www.grundfos.ro

Russia
ООО Грундфос Россия
ул. Школьная, 39-41
Москва, RU-109544, Russia
Тел. (+7) 495 564-88-00 (495) 737-30-00

North Harbour Industrial Estate
Albany, Auckland
Phone: +64-9-415 3240
Telefax: +64-9-415 3250

Norway
GRUNDFOS Pumper A/S
Strømsveien 344
Postboks 235, Leirdal
N-1011 Oslo
Tlf.: +47-22 90 47 00
Telefax: +47-22 32 21 50

Poland
GRUNDFOS Pompy Sp. z o.o.
ul. Klonowa 23
Baranowo k. Poznania
PL-62-081 Przeźmierowo
Tel: (+48-61) 650 13 00
Fax: (+48-61) 650 13 50

Portugal
Bombas GRUNDFOS Portugal, S.A.
Rua Calvet de Magalhães, 241
Apartado 1079
P-2770-153 Paço de Arcos
Tel.: +351-21-440 76 00
Telefax: +351-21-440 76 90

Romania
Grundfos Pompe România SRL
S-PARK BUSINESS CENTER,
Clădirea A2,
etaj 2, Str. Tipografilor, Nr. 11-15,
Sector 1,
Cod 013714, Bucuresti, Romania,
Tel: 004 021 2004 100
E-mail: romania@grundfos.ro
www.grundfos.ro

Russia
ООО Грундфос Россия
ул. Школьная, 39-41
Москва, RU-109544, Russia
Тел. (+7) 495 564-88-00 (495) 737-30-00

Факс (+7) 495 564 8811
E-mail grundfos.moscow@grundfos.com

Serbia
Grundfos Srbija d.o.o.
Omladinskih brigada 90b
11070 Novi Beograd
Phone: +381 11 2258 740
Telefax: +381 11 2281 769
www.rs.grundfos.com

Singapore
GRUNDFOS (Singapore) Pte. Ltd.
25 Jalan Tukang
Singapore 619264
Phone: +65-6681 9688
Telefax: +65-6681 9689

Slovakia
GRUNDFOS s.r.o.
Prievozská 4D
821 09 BRATISLAVA
Phona: +421 2 5020 1426
skgrundfos.com

Slovenia
GRUNDFOS Ljubljana, d.o.o.
Leskoškova 9e, 1122 Ljubljana
Phone: +386 (0) 1 568 06 10
Telefax: +386 (0) 1 568 06 19
E-mail: tehnika-si@grundfos.com

South Africa
Grundfos (PTY) Ltd.
16 Lascelles Drive, Meadowbrook
Estate
1609 Germiston, Johannesburg
Tel.: (+27) 10 248 6000
Fax: (+27) 10 248 6002
E-mail: lgradidge@grundfos.com

Spain
Bombas GRUNDFOS España S.A.
Camino de la Fuentequilla, s/n
E-28110 Algete (Madrid)

Tel: +34-91-848 8800
Telefax: +34-91-628 0465

Sweden
GRUNDFOS AB
Box 333 (Lunnagårdsgatan 6)
431 24 Mölndal
Tel.: +46 31 332 23 000
Telefax: +46 31 331 94 60

Switzerland
GRUNDFOS Pumpen AG
Bruggacherstrasse 10
CH-8117 Fällanden/ZH
Tel.: +41-44-806 8111
Telefax: +41-44-806 8115

Taiwan
GRUNDFOS Pumps (Taiwan) Ltd.
7 Floor, 219 Min-Chuan Road
Taichung, Taiwan, R.O.C.
Phone: +886-4-2305 0868
Telefax: +886-4-2305 0878

Thailand
GRUNDFOS (Thailand) Ltd.
92 Chaloeam Phrakiat Rama 9 Road,
Dokmai, Pravej, Bangkok 10250
Phone: +66-2-725 8999
Telefax: +66-2-725 8998

Turkey
GRUNDFOS POMPA San. ve Tic. Ltd. Sti.
Gebze Organize Sanayi Bölgesi
Ihsan dede Caddesi,
2. yol 200. Sokak No. 204
41490 Gebze/ Kocaeli
Phone: +90 - 262-679 7979
Telefax: +90 - 262-679 7905
E-mail: satis@grundfos.com

Ukraine
Бізнес Центр Європа
Столичне шосе, 103
м. Київ, 03131, Україна
Телефон: (+38 044) 237 04 00
Факс: (+38 044) 237 04 01
E-mail: ukraine@grundfos.com

United Arab Emirates
GRUNDFOS Gulf Distribution
P.O. Box 16768
Jebel Ali Free Zone
Dubai
Phone: +971 4 8815 166
Telefax: +971 4 8815 136

United Kingdom
GRUNDFOS Pumps Ltd.
Grovebury Road
Leighton Buzzard/Beds. LU7 4TL
Phone: +44-1525-850000
Telefax: +44-1525-850011

U.S.A.
GRUNDFOS Pumps Corporation
9300 Loiret Blvd.
Lenexa, Kansas 66219
Phone: +1-913-227-3400
Telefax: +1-913-227-3500

Uzbekistan
Grundfos Tashkent, Uzbekistan The
Representative Office of Grundfos
Kazakhstan in Uzbekistan
38a, Oybek street, Tashkent
Телефон: (+998) 71 150 3290 / 71 150 3291
Факс: (+998) 71 150 3292

Addresses Revised 09. 09. 2020

